



PERKEMBANGAN DESAIN RUANG OPERASI

🌐 | www.selaraslawangsewu.com

📘 | Selaras Lawang Sewu

📷 | [selaraslawangsewu_official](https://www.instagram.com/selaraslawangsewu_official)

🎵 | Selaras Lawang Sewu



RUANG OPERASI

SANDWICH PANEL | ENAMEL PANEL | PINTU HERMETIC | AKSESORIS RUANG OPERASI



KETERANGAN :

1. Hermetic Door
2. Vynil Flooring
3. Passbox
4. Gas Outlet
5. Lampu Operasi
6. Pendant
7. HEPA Filter
8. Lampu LED

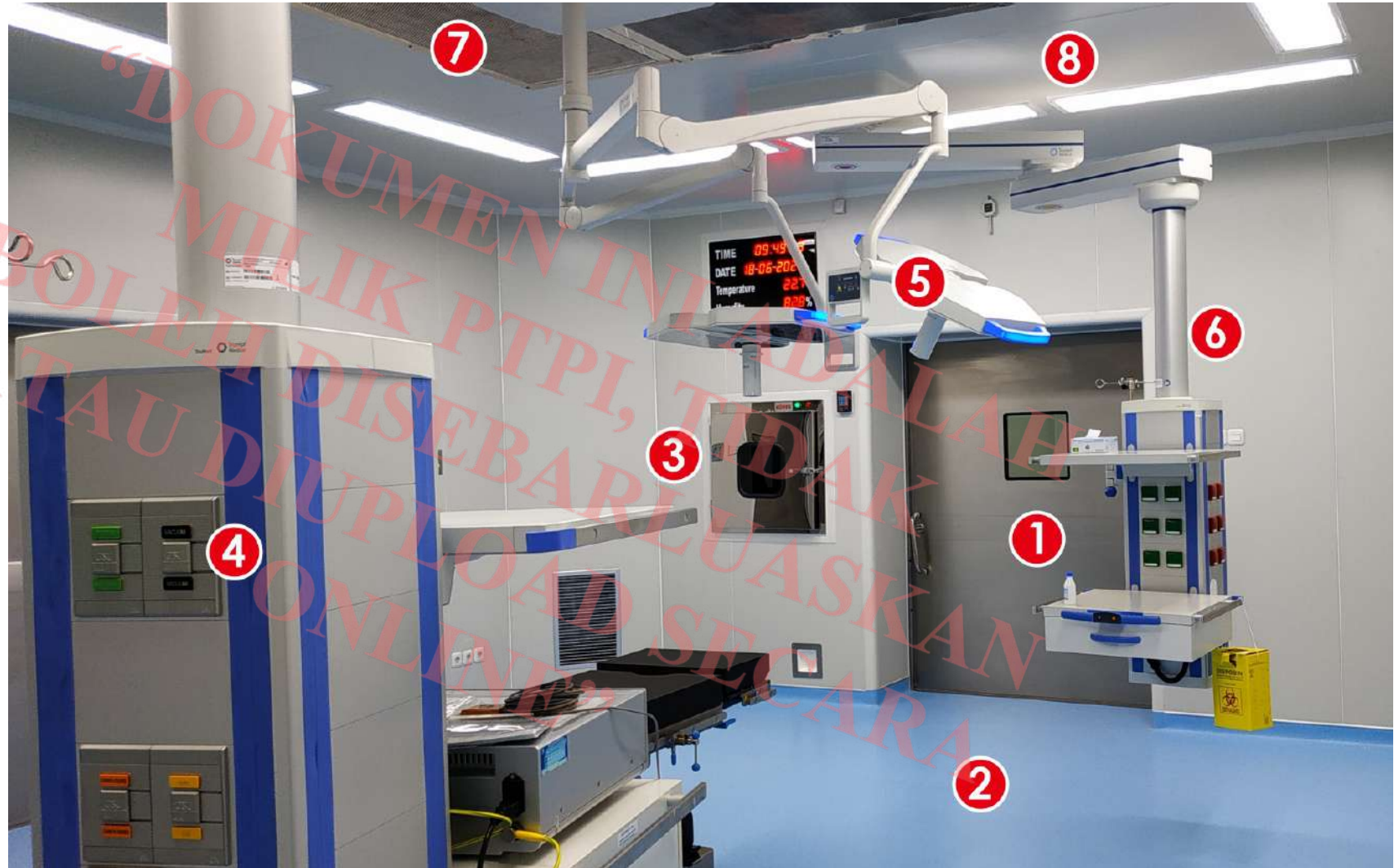

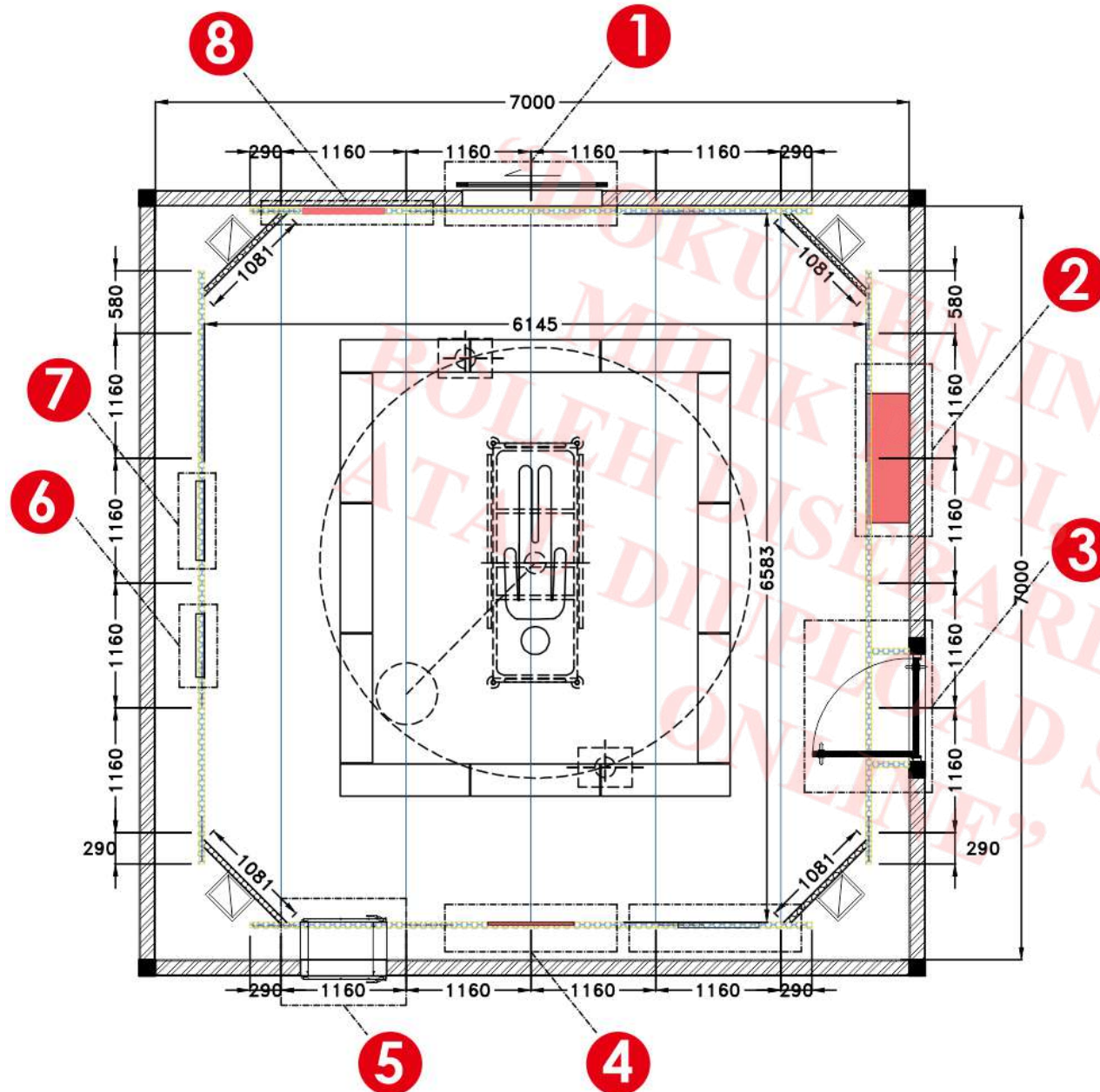

DENAH KERJA RUANG OPERASI

KETERANGAN :

1. Hermetic Door
2. Lemari Alat & Obat
3. Swing Steel Door
4. Film Viewer
5. Passbox
6. Power Ground Module
7. Wall Outlet Unit
8. Operating Timer

STANDARD RUANG OPERASI

✓ Minor 6m x 6m H:3m

- Wall Sandwich Schnell Panel Antibacterial / Enamel Schnell Panel Anti Backterial
- Ceiling Sandwich Panel Anti Bacterial / Enamel Schnell Panel Anti Backterial
- Accessories : Alm Curving & Consumable
- LED Light 40w
- KUPPE Operating Timer LED 32"
- KUPPE X-Ray Film 2 Viewer
- KUPPE Passbox SS SUS 304 Mirror Interlock System
- KUPPE Lemari Alat SS SUS 304 Mirror
- Electrical Socket Unit (PGM)

✓ Umum 7m x 6m H:3m

✓ Mayor 7,2m x 7m H:3m

- Wall outlet unit 4 Function (O,N,A,V)
- Lampu Indikator Ruang OK
- TORMAX Sliding Hermetic Single Door
- Swing Manual Stainless Door Single
- Vynil Homogenous
- Stainless Steel Scrubsink 2 Station
- System HVAC Ruang OK
- Instalasi Gas Medis

Kelengkapan lainnya :

- Pendant
- Lampu Operasi
- Meja Operasi

SANDWICH PANEL

EPS FR

(Expandable Polystyrene) Fire Retardant

PIR

(Polyisocyanurate)

SPESIFIKASI PRODUK EPS FR / PIR

Kelebihan dalam memakai sandwich panel :

- Tahan Api
- Anti bakterial
- Proses instalasi yang cepat
- Dapat menjaga temperatur, kelembaban, dan tekanan secara stabil
- Dapat diaplikasikan di dalam maupun diluar ruangan

Material :

- EPS (Expandable Polystyrene)
- PIR (*Polyisocyanurate*)

Grade

- Tahan Api
- Anti Bakteri



Sound Insulation Value (EPS FR)

Ketebalan(mm)	50	75	100	150	200
R (db)	20.0	21.5	23.0	26.0	29.9

SANDWICH PANEL EPS FR / PIR

No	Description	
1	Material Plate	Zinc Alume
2	Plate Thickness	
	• Wall	0,45mm up to 0,6mm
	• Ceiling	0,45mm up to 0,6mm
3	Coating Thickness	Up to 60 micron
4	Coating Type	Anti Bacterial
5	Custom Color	Off White
6	Effective Width Dimension	1000mm / 1160mm
7	Max Length Panel	Up to 12 meters
8	Panel Thickness	50mm, 75mm, 100mm, 150mm, 200mm
9	EPS FR & PIR Type	Fire Retardant
10	EPS FR Density	18 Kg/m ³
11	PIR Density	40 Kg/m ³

SANDWICH PANEL REFERENCES



VIDEO RUANG OPERASI SANDWICH PANEL EPS FR & PIR

**“DOKUMEN INI ADALAH
MILIK PTPI, TIDAK
BOLEH DISEBARLUASKAN
ATAU DIUPLOAD SECARA
ONLINE”**



VIDEO RUANG OPERASI SANDWICH PANEL DENGAN PANEL KACA

PROJECT REFERENCE

RUANG OPERASI SANDWICH PANEL EPS & PIR

1. RS Mayapada Kuningan - Jakarta
2. RS Abdi Waluyo Menteng - Jakarta
3. RS Bunda Aliyah Depok - Jakarta
4. RS Ukrida - Jakarta
5. RS Port Medical Center (PMC) tj. Priok
6. RS Drajat Serang - Banten
7. RSUD Tangsel - Banten
8. RS Paramarta - Bandung
9. RS Bhayangkara AKPOL - Semarang
10. Charlie Hospital - Semarang
11. RSUP Klaten - Yogyakarta
12. RSUD Wates - Yogyakarta
13. RS JIH - Yogyakarta
14. RSI Hidayatullah - Yogyakarta
15. RS. Panti Rapih - Yogyakarta
16. RSU Muhammadiyah – Yogyakarta
17. RSUD Semanggi / Bung Karno - Solo
18. RS Paru - Solo
19. RS JIH - Solo
20. RS Indriati - Solo
21. RS PKU Muhammadiyah - Solo
22. RSUD Soehadi - Solo
23. RS. Amal Sehat - Sragen
24. RS Indriati - Boyolali
25. RS PKU Muhammadiyah - Jepara
26. RS Mardi Rahayu - Kudus
27. RSU Siaga Medika - Purbalingga
28. RSUD Banyumas - Banyumas
29. RSKS - Pati
30. RS. Karangawen - Demak
31. RSUD Suradadi - Tegal
32. RSUD Kardinah - Tegal
33. RS Priscilla - Cilacap
34. RS Soewandhi - Jawa Timur
35. RSUD Sidoarjo - Jawa Timur
36. RSU Aisyiyah Ponorogo - Jawa Timur
37. RSUD Sanjiwani Gianyar - Bali
38. RSUD Negara - Bali
39. RSPTN Univ. Udayana - Bali
40. RS Balimed - Bali
41. RS Banjarbaru - Kalimantan Selatan
42. RS Soedarso - Pontianak
43. RS Tadjudin Chalid - Makassar
44. RSUD Konawe - Sulawesi Tenggara
45. RS Undata - Palu
46. RSUD Patut Patuh Patju - Lombok
47. RS Jauwhanes - Kupang
48. RS Agoes Djam - Ketapang
49. RSUD Ben Mboi - Ruteng
50. RSUD Dr. P. P. Magretti Saumlaki - Maluku
51. RSUD Kaur - Bengkulu
52. RSUD Bukit Tinggi - Sumatera Barat
53. RS BP Batam - Riau
54. RS Rasidin Padang - Padang
55. RS Unand Padang - Padang
56. RS Harapan Bunda Banda Aceh - Aceh

KÜPPE CRYSTALLIZE SANDWICH PANEL

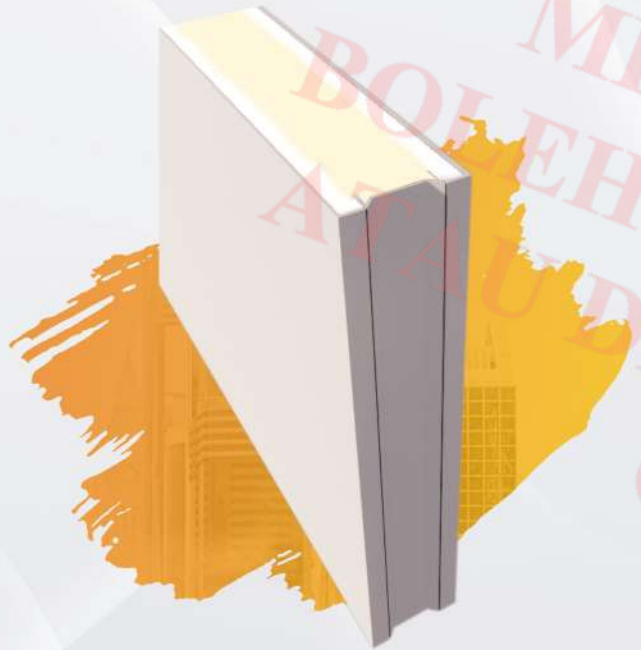

FIRE RESISTANT CERTIFICATE



BUKAN KUMEN INI MILIK PTPI, TIDAK BOLEH DISEBARLUAR, HARUS DIUPLOAD SECARA ONLINE

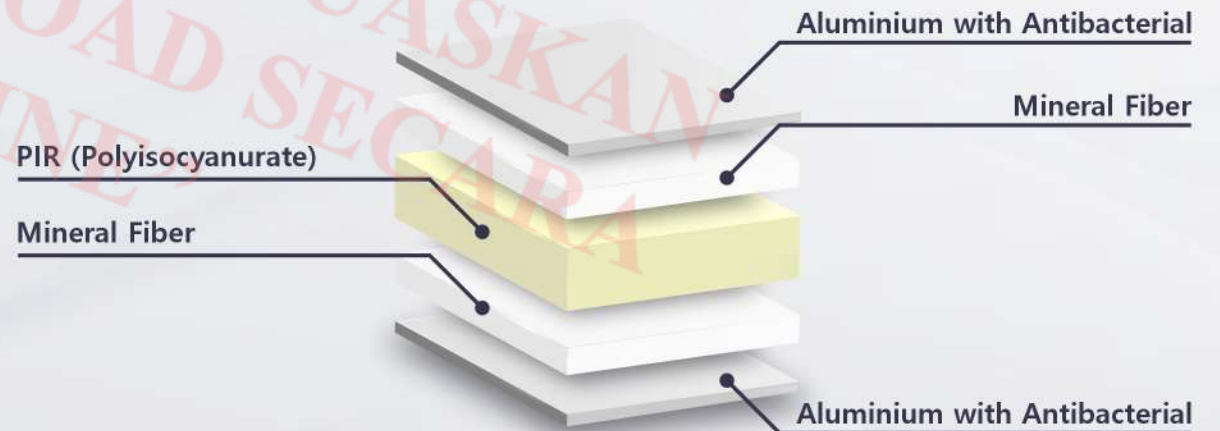

**2 JAM
TAHAN API**



**MUDAH
DIAPLIKASIKAN**



**HARGA
TERJANGKAU**

ENAMEL PANEL

SCHNELL ENAMEL PANEL

- Dinding dan Plafond tahan api 2 jam
- Sistem dinding modular dapat mengikuti kondisi bangunan.
- Lapisan anti bacterial.

Enamel Panel mempunyai 3 tipe yaitu :

1. Stainless Steel Coating Panel
2. Stainless Steel Panel
3. Glass Panel

STAINLESS STEEL COATING PANEL

- Permukaan : Stainless steel SUS 304 ketebalan 0,8 mm, bisa di coating warna anti bacterial dengan ketebalan minimal 60 micron dan tahan api, Gypsum Board Fire Stop 13mm, Rockwool 100kg/m³
- Warna dinding tersedia dalam berbagai warna.

Tersedia 4 jenis Pilihan Warna :

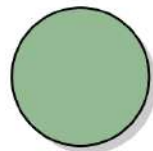

Hijau

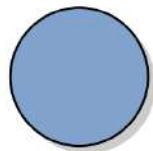

Biru



Putih



Cream



STAINLESS STEEL COATING PANEL



STAINLESS STEEL PANEL

- Permukaan : Stainless steel SUS 304 ketebalan 0,8 mm, dan tahan api, Gypsum Board Fire Stop 13mm, Rockwool 100kg/m³



STAINLESS STEEL PANEL



GLASS PANEL

- Lapisan didalamnya kaca tempered 12 mm printing.



GLASS PANEL



DOKUMEN INI BOLEH DISEBARLUASKAN ATAU DIUPLUAD SECARA ONLINE. BUKAN MILIK PTPI, TIDAK ADALAH

PROJECT REFERENCE

RUANG OPERASI ENAMEL PANEL

1. RS Cahya Kawaluyan - Bandung
2. RSUD Pemengpeuk - Jawa Barat
3. RSU Dr. Soeradji Tegalyoso - Klaten
4. RSI Hidayatullah - Yogyakarta
5. RSUD Kartini – Jepara
6. RSUD Soedono, Madiun - Jawa Timur
7. RSUD Srengat, Blitar - Jawa Timur
8. RS RKZ Surabaya - Jawa Timur
9. RSUP Rifa'i Abdullah - Palembang

VIDEO RUANG OPERASI ENAMEL PANEL

**“DOKUMEN INI ADALAH
MILIK PTPI, TIDAK
BOLEH DISEBARLUASKAN
ATAU DIUPLOAD SECARA
ONLINE”**

PINTU HERMETIC

“DOKUMEN INI ADALAH MILIK PTPT, TIDAK BOLEH DISEBARLUASKAN ATAU DIUPLOAD SECARA ONLINE”

Touch. Free Movement . Health Counts

In emergency situations, second can count, hygiene always count.

Rapid movement is as essential as a hygienic theatre. Automatic door that open and close quickly without any physical contact really count.

Application Area :

- * Operating Room
- * Endoscopy
- * ICU
- * Recovery

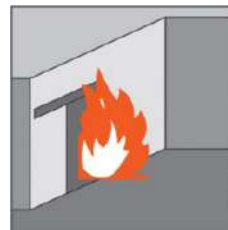

Fire Protection

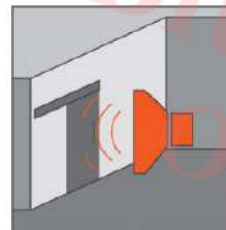

Noise Protection

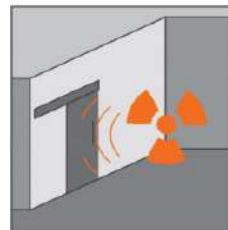

X-ray Protection

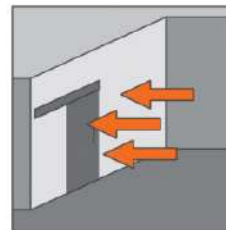

Hermetic

Pintu Hermetic **BERBEDA** dengan pintu otomatis

HERMETIC DOOR



NON-HERMETIC DOOR



TERBUKA

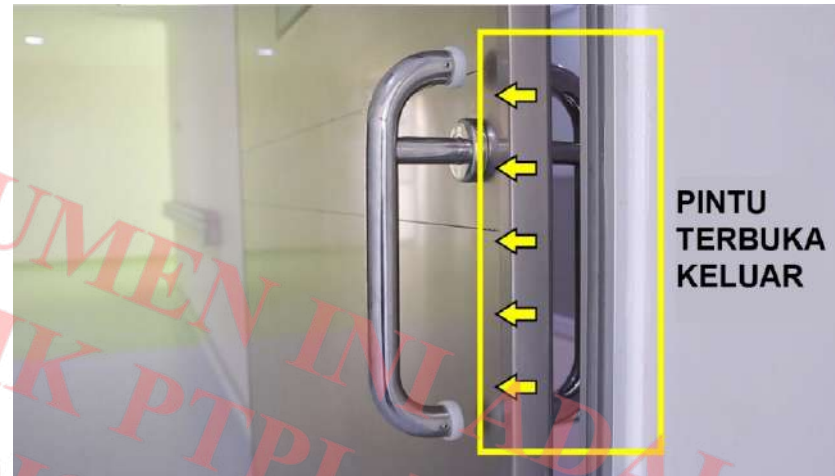

TERTUTUP

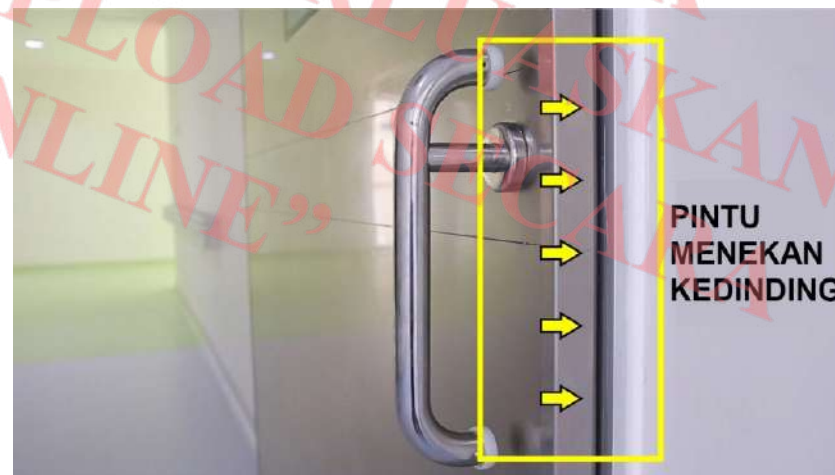

“

Pintu Hermetic
juga berfungsi
untuk menjaga
Suhu, Tekanan &
Kelembaban
Ruang Operasi

”

HERMETIC SLIDING DOOR SINGLE



CLEAR OPENING WIDTH

- Single door (Small) 900mm
(Large) 1600mm
- Height 2150mm

MATERIAL

The head rail of sliding door is made of aluminium alloy

Door : SS foam insulated

Cover : Aluminium Anodized

Handle : Stainless Steel

HERMETIC SLIDING DOOR DOUBLE



- Clear Opening Width : 1800mm
Height : 2150mm
- Window : 400x400mm double frameless
- Safety : 4 safety beam sensor
- Double rubber seal in 4 sides of the door
- Delay for opening : 2 – 20 s
- Door close force : >70N
- Manual open force : <100N
- Power Consumption : 150 VA

VIDEO HERMETIC DOOR

**“DOKUMEN INI ADALAH
MILIK PTPI, TIDAK
BOLEH DISEBARLUASKAN
ATAU DIUPLOAD SECARA
ONLINE”**

HERMETIC X – RAY DOOR UNTUK RUANG OPERASI BERTIMBAL & RUANG BERADIASI



X-Ray Room according to aimed where required handling and special attention for safeties. Equip with lead plate inside of the door, guarantee to protect the people from X-Ray Radiation.

Specification

- ✓ **Clear opening width**

Single door	(Small)	900mm
	(Large)	1600mm
Double Door		1800mm
Height		2150mm
- ✓ **Material**
 - The Head rail of sliding door is made of aluminium alloy.
 - Door : SS insulated with foam lead plate with lead equivalent 1 mmPb – 2 mmPb is put inside of the door to contain the X-RAY radiation
 - Cover : Aluminium Anodized
 - Handle : Stainless Steel
- ✓ **Window** : Double anti radiation glass
- ✓ **Safety** : 2 Safety beam sensor
- ✓ **Double rubber seal** in 4 sides of the door
- ✓ **Delay for opening** : 2-20 s
- ✓ **Door close force** : > 70 N
- ✓ **Manual open force** : < 100 N
- ✓ **Power Consumptions** : 150 VA

TORMAX HERMETIC SWING DOOR



Protection of life

Directors of hospital and care homes, senior consultant, safety personal and most importantly, patients all benefit from automatic doors. Interlinked safety systems provide access control, rapid access control and fulfill the requirement for sterile environments.

HERMETIC SWING DOOR SPECIFICATION

Specification Table

<ul style="list-style-type: none"> ✓ Clear opening width Single door 1000mm Double door 2000mm Height door 2150mm ✓ Opening angle 0° - 110° ✓ Manual open force 30N ✓ Operation noise < 50 dB ✓ Delay for opening < 1-20s ✓ Power Consumptions 3-140W 	<ul style="list-style-type: none"> ✓ Material - The head rail of Swing door is made of aluminium alloy - Door : SS foam insulated Cover : Aluminium Anodized Handle : Stainless steel - Double rubber seal in 4 sides of the door - Window : 400x400mm double glass frameless
---	---

VIDEO HERMETIC SWING DOOR

**“DOKUMEN INI ADALAH
MILIK PTPI, TIDAK
BOLEH DISEBARLUASKAN
ATAU DIUPLOAD SECARA
ONLINE”**

AKSESORIS RUANG OPERASI

PASSBOX

FUNGSI :

- Sebagai akses peralatan yang akan digunakan untuk operasi.
 - Interlock System.
 - Sinar UV.
- Tersedia juga Passbox dengan timbal



PASSBOX

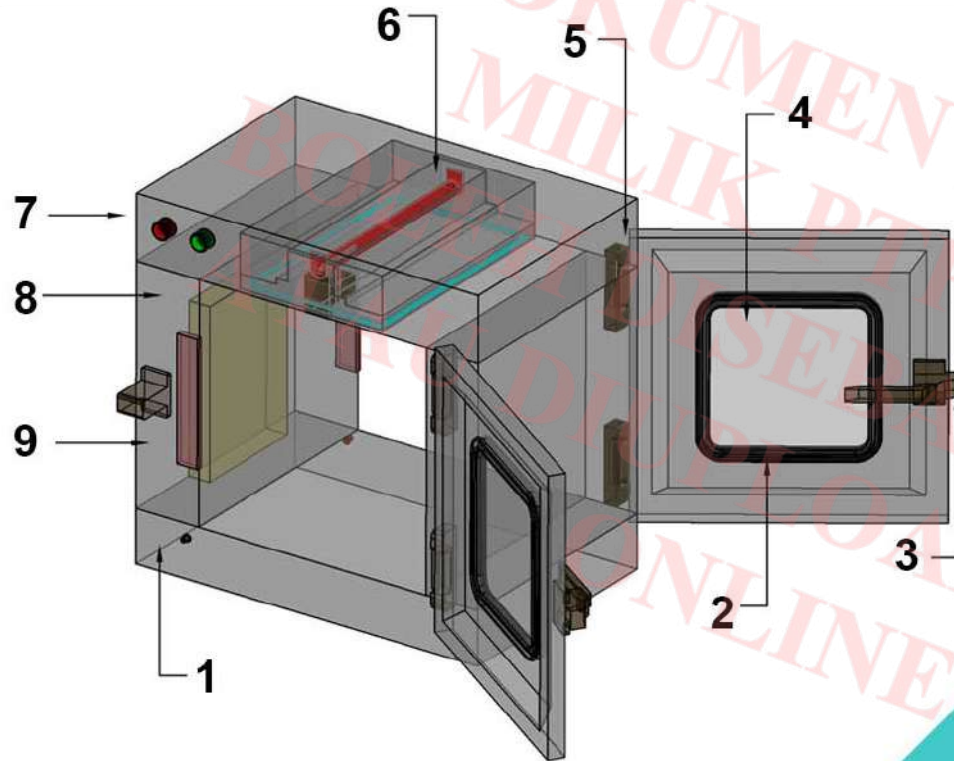

1. Switch Z 56 QB
2. Seal
3. Handle
4. Tempered Glass T= 5mm
5. Hinge
6. Lights UV
7. Light LED 22 V
8. Electrical
9. Magnetic Interlock

SPECIFICATION

- Material : SS 304 (Thick 1.5mm)
- Outer Size : (800x800x500) mm / (600x600x500) mm
- Body Construction : SUS 304 Thick 1.5mm
- Finishing : Hairline SS / Mirror SS
- Accessories : LED Lights 22mm diameter, 220V
- LED Color : Red & Green
- Ultraviolet Lights (UV)
- Magnetic Interlock
- Power supply, Pilot lamp, Switch, Relay, Hinge Handle, Seal
- Tempered Glass

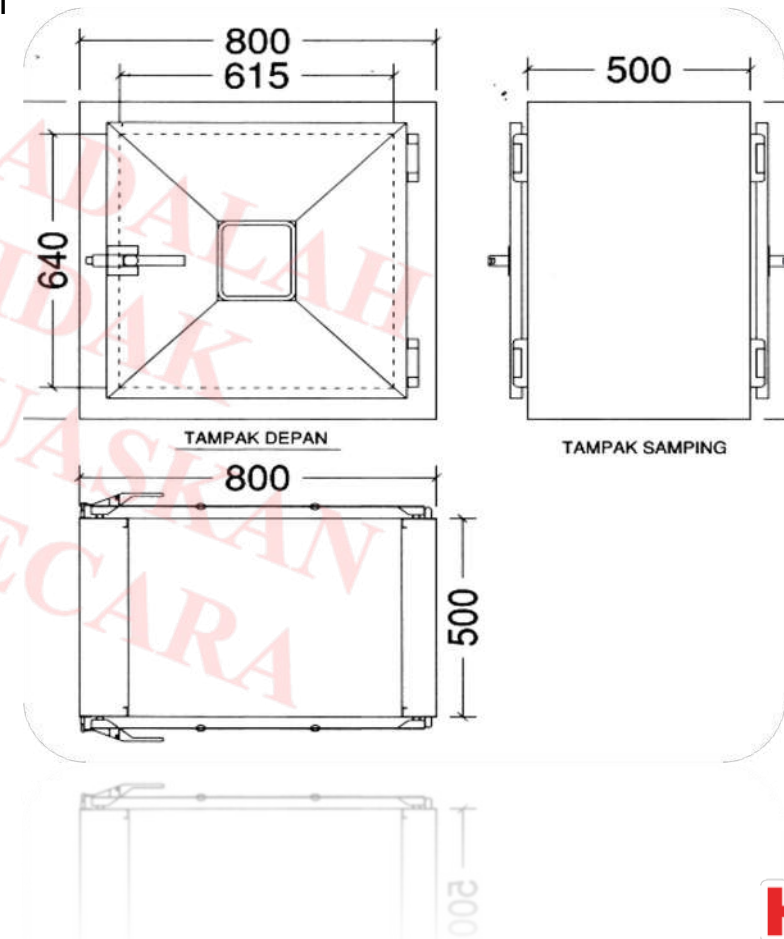

VIDEO PASSBOX

**“DOKUMEN INI ADALAH
MILIK PTPI, TIDAK
BOLEH DISEBARLUASKAN
ATAU DIUPLOAD SECARA
ONLINE”**

DISPOSAL

Disposal digunakan untuk transfer barang kotor/ linen kotor dari dalam ruang operasi ke koridor kotor.

Menggunakan material Stainless Steel SUS 304 dengan ketebalan 1mm – 1,5mm dan dilengkapi sistem interlock.



VIDEO DISPOSAL

**“DOKUMEN INI ADALAH
MILIK PTPI, TIDAK
BOLEH DISEBARLUASKAN
ATAU DIUPLOAD SECARA
ONLINE”**

OPERATING TIMER

Operating Timer adalah papan informasi digital untuk melihat jam atau waktu, tanggal, temperatur suhu dan timer pada saat didalam ruang operasi.



X-RAY VIEWER

Xray Viewer adalah alat yang digunakan untuk melihat hasil rontgen pasien.

Biasa diletakkan di bagian dinding ruang operasi.

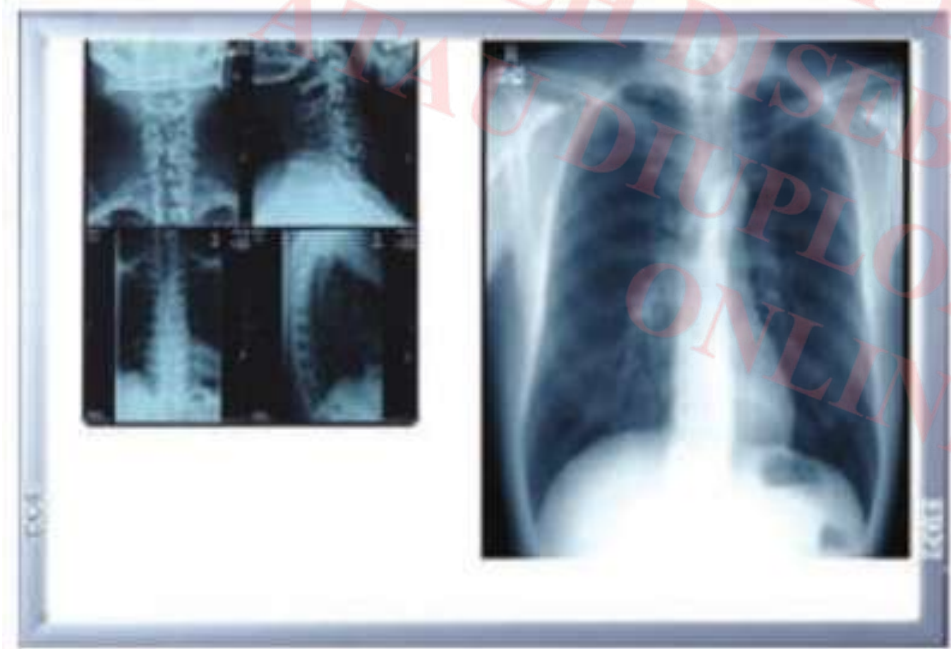

LEMARI CABINET



- Lemari Cabinet merupakan lemari penyimpanan medis untuk obat dan peralatan di ruang operasi.
- Dibuat dari stainless steel sus 304.
- Mudah dibersihkan.
- Anti karat dan menjaga obat-obatan atau perlengkapan operasi tetap steril.

COOLER & WARMER CABINET



Cooler & Warmer Cabinet merupakan lemari untuk penyimpanan suhu dingin dan hangat guna menjaga sterilisasi.

POWER GROUND MODULE



Merupakan penyalur arus listrik bagi komponen di ruang Operasi.

MEDICAL GAS OUTLET



Medical Gas Outlet merupakan komponen ruang operasi yang berfungsi untuk menyalurkan gas medis O, N, A, V.

**VIDEO OPERATING TIMER, X-RAY, LEMARI CABINET, COOLER WARMER CABINET &
POWER GROUND MODULE**

**“DOKUMEN INI ADALAH
MILIK PTPI, TIDAK
BOLEH DISEBARLUASKAN
ATAU DIUPLOAD SECARA
ONLINE”**

LAMPU LED



Lampu penerangan LED adalah lampu penerangan ruangan operasi yang difinishing antibacterial, yang berfungsi memberikan pencahayaan dengan maksimal.

Intensitas cahaya minimal adalah 200Lux.

WRITING TABLE



Merupakan meja tulis yang terdapat di dalam ruang MOT untuk media dokter mencatat hasil observasi selama tindakan operasi.

CONTROL PANEL

Salah satu komponen yang terintegrasi dengan ruang operasi.
Terdapat juga Control panel dengan Touch Screen System.

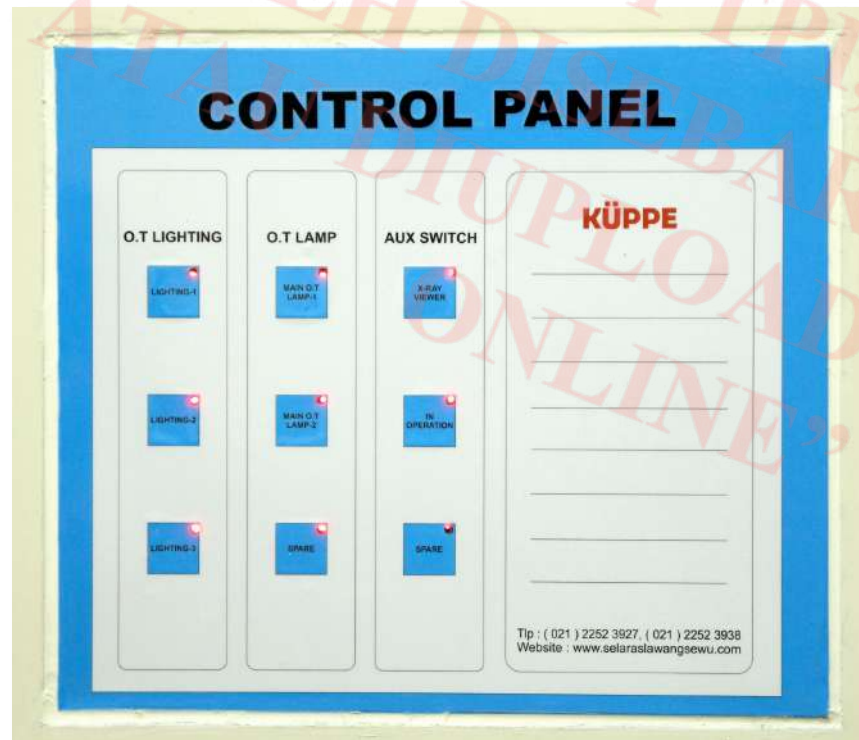

VIDEO CONTROL PANEL

**“DOKUMEN INI ADALAH
MILIK PTPI, TIDAK
BOLEH DISEBARLUASKAN
ATAU DIUPLOAD SECARA
ONLINE”**

Single Fixed Arm Pendant SF Series



Single Fixed Arm version consist of central ceiling with rotation axle and one movable carrying arm. Various service head can be attached to interface flange.

Double Fixed Arm Pendant DF Series



Double Fixed Arm version Consist of central ceiling mounting with rotation axle and two movable carrying arms. Various service head can be attached to interface flange.

CEILING PENDANT SYSTEM

Manual System

ICU Twin Pendant DUO Series



ICU Twin Pendant Version offer a wide range of design possibilities for customer specific service supply unit from one single ceiling mounting

OPERATING LAMP



- Illuminance : $\geq 140.000/\geq 120.000$ Lux Colour
- Illuminance Depth : $\geq 1300\text{mm}^2$
- Size of Light Field : 160-280mm
- Power Supply Voltage : AC110-240V, 50/60Hz
- Brightness Adjustment : Automatic - Stage Continuous Light Adjustment
- Lowest height of installation : 2900mm
- Total Power Consumption : 140W
- Total LED Bulb Quantity : 180 Pcs (18*6+12*6)
- Camera & TV Integrated (optional)

OPERATING TABLE



Electric operating table is used for general surgery, heart & kidney orthopedics, neurosurgery, gynecology, urology and other surgical. Driven by Low Voltage DC Motor with advance backup power, safe and reliable.

The leg board can open and is removable. The base cover is made of stainless steel, slushing and easy to clean.

- Length : 2020mm
- Width : 500mm
- Min Height : 550mm
- Max Height : 800mm

VINYL

Syarat Vinyl untuk Ruang Operasi:

- Tebal lapisan Vinyl 2mm
- Anti bakteri
- Mudah dibersihkan
- Elastis
- Tahan terhadap bahan kimia
- Tahan Gores





SCRUBSINK

Tempat cuci tangan dengan teknologi automatic sensor dan dilengkapi dengan UV Sterilizer Technology, Automatic Hand Dryer, Soap Dispenser dan Water Filter 1 Micron.

VIDEO SCRUBSINK

**“DOKUMEN INI ADALAH
MILIK PTPI, TIDAK
BOLEH DISEBARLUASKAN
ATAU DIUPLOAD SECARA
ONLINE”**

Clean Room System

Standard Temperature : 19°C - 24°C

Humidity : 45% - 60%

Air Pressure : Positive

Air Exchange : 20x per hour

- AHU (Air Handling Unit) – Cooling Capacity
- Differential pressure indicator
- Ducting
- Filtration System (Laminar Air Flow – Housing Ceiling Unit)
- Refrigerant & Drainage Pipping
- Panel Control AHU
- Wiring Cable



Mechanical Electrical (ME)

- Wiring System
- Isolator Transformer
Alternatif 5.000 watt / 10.000 watt / lebih
- UPS 10kVA / 20kVA / lebih

PROJECT REFERENCES

“DOKUMEN INI ADALAH MILIK PTPTI DAN BOLEH DIUNDUH ATAU DIUPLOAD SECARA ONLINE”

MAP OF PROJECT REFERENCES

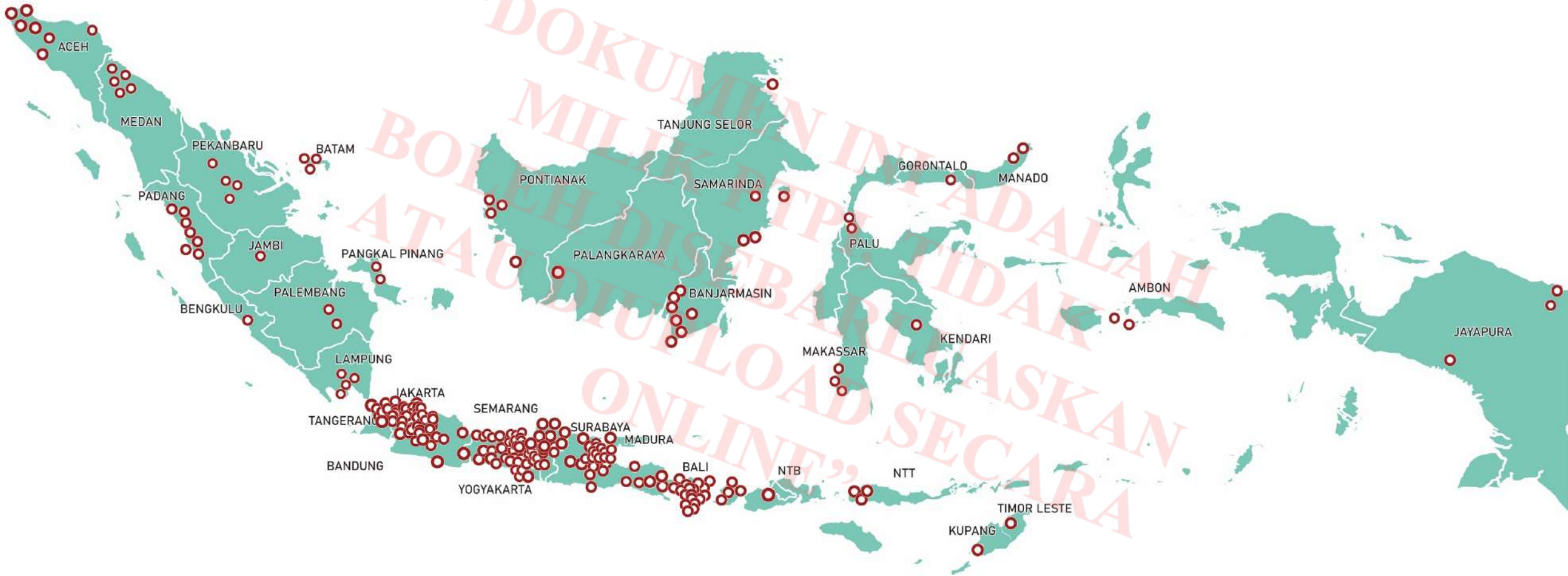

JABODETABEK

Proyek RS Citra Garden City 5
Proyek RS Pondok Indah
Proyek Atmajaya
Proyek Harapan Kita
Proyek Jakarta Eyes Center
Proyek RSUD Fatmawati
Proyek Hospital Mayapada - TB Simatupang
Proyek RS ANTAM Medika
Proyek Tanjung Priok
Proyek Puri Mandiri - Kedoya
Proyek RS Nisa
Proyek RS Ukrida
Proyek Smart Marunda
Proyek RS Medistra
Proyek Ciputra Medical Center
Proyek RSUD Pesanggrahan
Proyek RSCM Kirana
Proyek RS TNI AL Mintoarjo
Proyek RS Mayapada
Proyek RSUD Taman Sari
Proyek RSUD Tarakan (Sky Hospital)
Proyek Klinik Indrajana
Proyek RS Husada
Proyek Brawijaya Healthy Care Group
Proyek RS Cimacan
Proyek RS Leuwiliang - Bogor
Proyek RS Pertamina - Sentul
Proyek Bunda Aliyah - Depok
Proyek RSUD - Cibinong
Proyek IBS RSUD - Cibinong
Proyek RS Unimedika - Bekasi
Proyek RS Sentosa - Bekasi
Proyek Royal Dental Hospital - Tangerang
Proyek RS Citereup
Proyek RS Graha MM2100 - Cibitung
Proyek RSIA Bina Medika - Bintaro
Proyek RS Bhakti Asih
Proyek RSUD Tangerang Selatan

PROJECT REFERENCE

JAWA TENGAH

Proyek RSUD Prembun - Kebumen
Proyek RS Blora
Proyek RSUD - Temanggung
Proyek RSUD Prof. Dr. Margono Soekarjo - Banyumas
Proyek RS Tugu - Semarang
Proyek SMC RS Telogorejo Semarang
Proyek RS Colombia Asia - Semarang
Proyek IBS ICU Terpadu RSUD - Semarang
Proyek Mitra Bangsa - Pati
Proyek PKU Muhammadiyah Mayong - Jepara
Proyek PKU Muhammadiyah - Surakarta
Proyek RS Brebes
Proyek RSUD - Salatiga
Proyek RS Purworejo
Proyek RS JIH - Solo
Proyek IGD RSKS - Pati
Proyek OEN - Solo
Proyek RS Akpol - Semarang
Proyek RSUD Wongsonegoro - Semarang
Proyek RSUD - Muntilan
Proyek RSUD - Batang
Proyek RSUD KRT Setjonegoro - Wonosobo
Proyek RSUD Kardinah - Tegal
Proyek IBS RSUD Hj Anna Lasmanah - Banjarnegara
Proyek RSUD - Ambarawa
Proyek RSUD Sragen

Proyek RSUI Harapan Anda - Tegal
Proyek RSUP Dr. Kariadi - Semarang
Proyek RS PKU Muhammadiyah - Gombong
Proyek RS Purworejo
Proyek RSUD Wongsonegoro
Proyek RSGMP Unimus
Proyek RS Sultan Agung - Semarang
Proyek RSUD Ambarawa
Proyek RS Fastabiq Sehat - Pati
Proyek RSUD Batang
Proyek RSUD - Rembang
Proyek RSUD RA Kartini - Jepara
Proyek RSUD Raden Patah arang Awen - Demak
Proyek Charlie Hospital - Semarang
Proyek RSUP Klaten
Proyek RSUD Goeteng - Purbalingga
Proyek RS Paru Jajar - Surakarta
Proyek RSUD Bung Karno - Solo
Proyek RS Indriati - Solo
Proyek RS Indriati - Boyolali
Proyek RS PKU Singkil - Tegal
Proyek RS Bina Husada - Rembang
Proyek RS Priscilla Cilacap
Proyek RSIAD Purbalingga
Proyek RSI Kudus
Proyek RSUD Dr. Loekmono Hadi Kudus
Proyek RS Panti Wilasa Citarum Semarang
Proyek RS Amal Sehat - Sragen
Proyek RS Ibnu Sina - Sragen

YOGYAKARTA

Proyek PKU Muhammadiyah
Proyek RSGM UGM
Proyek RS Saptosari
Proyek RS UII
Proyek RS UMY
Proyek RS Pantj Rapih
Proyek RSUP Dr. Sardjito
Proyek RS JIH
Proyek RSUD Wates Kulon Progo
Proyek RSI Hidayatullah
Proyek RSUD Bantul
Proyek RSUD - Sleman
Proyek RSGM UMY
Proyek RSUD Penembahan Senopati Bantul

SULAWESI

Proyek RS Gorontalo
Proyek RS Madani - Palu
Proyek RSUD Undata - Palu
Proyek RS Siloam - Manado
Proyek RS Manado
Proyek RSUD - Konawe
Proyek RSUP Tadjudin Chalik - Makassar
Proyek RS Bhayangkara - Makassar

JAWA BARAT

Proyek RS Hasan Sadikin - Bandung
Proyek RS Persada Medik
Proyek RSIA Permata Pertiwi
Proyek RS Dustira
Proyek Melinda Hospital
Proyek RSUD Langensari
Proyek RSKIA Bandung

KALIMANTAN

Proyek RS Awal Bross - Pekanbaru
Proyek RSUD Arifin Ahmad - Pekanbaru
Proyek RS Banjar Baru
Proyek RSUD Tenggara
Proyek Pontianak Hospital
Proyek RSUD Balikpapan
Proyek Benawa Raya
Proyek Ciputra Mitra Hospital - Banjarmasin
Proyek RSUD Dr. Agoesdjam Ketapang
Proyek RS Pertamedika Tarakan

JAWA TIMUR

Proyek RS Haji - Surabaya
Proyek RS Unair - Surabaya
Proyek Delta Surya - Sidoarjo
Proyek RSUD - Mojokerto
Proyek SILOAM Hospital - Surabaya
Proyek RS Adi Husada - Surabaya
Proyek RS Cendana Kanigoro - Blitar
Proyek Gedung Radio Terapi RS Malang
Proyek RS Lavalette - Malang
Proyek Dr. Soetomo - Surabaya
Proyek RS Adhi Husada - Surabaya
Proyek RSMU Blitar
Proyek RS Medika Mulia - Tuban
Proyek IGN Tahap II 18 RSUD - Sidoarjo
Proyek RS Islam - Malang
Proyek RSUD Sidoarjo
Proyek RSUD Bangkalan - Madura
Proyek RS Al Huda - Banyuwangi
Proyek RS Mata Undaan - Surabaya
Proyek RS Muhammadiyah Babat - Lamongan
Proyek STOC 18 (Gedung STOC Dr. Soetomo)
Proyek RS Karsa Husada
Proyek RSU Jombang
Proyek RS Lumajang
Proyek RSUD Srengat Blitar
Proyek RSUD Soedono Madiun

SUMATERA

Proyek RS Ibnu Sina - Padang
Proyek RS Udand - Padang
Proyek RS Hanafiah Batu Sangkar
Proyek RSUD Padang Panjang
Proyek RSUD IDI - Aceh Timur
Proyek RS Semen Padang
Proyek Murni Teguh - Medan
Proyek RS Adam Malik - Medan
Proyek RS Charitas - Palembang
Proyek RS Pelabuhan - Palembang
Proyek RSJ Tampan - Riau
Proyek RS Harapan Bunda - Banda Aceh
Proyek RSUD - Meulaboh
Proyek RSUD Duri - Riau
Proyek Awal Bross - Batam
Proyek RS KIM - Pangkal Oinang
Proyek RS Universitas Andalas
Proyek RS BP Batam
Proyek RS Tiara Sella - Bengkulu
Proyek Sufina Aziz - Medan
Proyek RS Datu Beru - Aceh
Proyek RS Paru - Lubuk Alung
Proyek RS Rasiding - Padang
Proyek RS Kim Pangkalpinang
Proyek RSUD Rivai Palembang
Proyek RS. Harapan Bunda Aceh

BALI

BALI

Proyek RSUD Klungkung

Proyek RSUD Gianyar

Proyek RSUD Wangaya

Proyek RS Balimed Buleleng

Proyek RSPTN Universitas Udayana

Proyek Badung Blok E

Proyek RS Mata Balimandara - Denpasar

Proyek RS Mata Balimandara - Sanur

Proyek RSUD Mangusada - Badung

Proyek RSUD Negara - Jembrana

Proyek RSUP Sanglah

Proyek RS Kasih Ibu - Denpasar

Proyek RS Kasih Ibu Saba

Proyek RS Kasih Ibu - Tabanan

NUSA TENGGARA BARAT

NUSA TENGGARA BARAT
Proyek RSUD Mataram
Proyek RS Islam - Lombok Timur
Proyek IGD RSUD Mataram
Proyek RSUD NTB
Proyek RSUD Mataram
Proyek RS Ibu Dan Anak Lombok Timur

NUSA TENGGARA TIMUR

NUSA TENGGARA TIMUR
Proyek RSUD Manggarai Timur - Flores
Proyek RSUD Ben Mboi
Proyek RSUD - Kupang

MALUKU

MALUKU
Proyek RS UPT Vertikal - Ambon

PAPUA

PAPUA
Proyek Provita - Jayapura

SERTIFIKASI

Sertifikasi yang harus dipenuhi sebagai Sub-Cont dalam Pembangunan Gedung Bangunan Kesehatan :

- Sertifikasi Badan Usaha Jasa Pelaksana Konstruksi dengan Sub Kualifikasi M1, dengan Kode Klasifikasi BG008 tentang Jasa Pelaksana Untuk Konstruksi Bangunan Kesehatan.
- Sertifikasi Tingkat Komponen Dalam Negeri (TKDN)



ISO 9001:2015

Quality Management System



ISO 14001:2015

Environmental Management System



ISO 45001:2018

Occupational Health & Safety



“Sebaik apapun produk, tidak ada artinya tanpa **Service** dan ketersediaan **Spare Parts.**”





AFTER-SALES SERVICE

- We also provide After-Sales Service for our product.
- Customer Service that always ready to be call.
- Prioritizing customer service and satisfaction
- Reliable and Experienced technicians.
- Providing Service and Maintenance for All Automatic Door Brands.



PRODUCT WARRANTY

- We always provide warranty for each our products, which customers will receive one-year warranty, depending on the cause of damage on the product.
- Customer will receive certificate of warranty.



SPARE PARTS AVAILABILITY

- Original Spare Parts
- The best Quality spare parts.
- Durable spare parts.

OFFICE



HEAD OFFICE

Daan Mogot km. 19 Kawasan Pergudangan
Tunas Blok A No. 7, Jl. Laksamana Yos Sudarso,
Kel. Kebon Besar, Kec. Batu Ceper, Tangerang

HP: 0888 1000 300

Fax : 021 2967 1465

Tlp : • 021 2252 3937

• 021 2252 3938



BRANCH OFFICE

Tumpang Raya No. 39, Kelurahan Petompon,
Kecamatan Gajahmungkur, Kota Semarang,
Jawa Tengah

HP: • 0888 1000 200

• 0888 1000 822

Tlp/Fax : 024 76 420 883



BRANCH OFFICE

Pergudangan Tanrise South
Gate, Blok B No. 20, Jl. Nangka-
Sruni, Sidoarjo, Jawa Timur.

OUR **SOCIAL**
MEDIA

 | www.selaraslawangsewu.com

 | [selaraslawangsewu_official](https://www.instagram.com/selaraslawangsewu_official)

 | Selaras Lawang Sewu

 | Selaras Lawang Sewu



Selaras Lawang Sewu
Door & Window Solution



THANK YOU